

# Data Sheet



Article number: 390215000755010

Description: Worm gear  
VF 150-FC2-7-132B5, without lubrication

## Measures

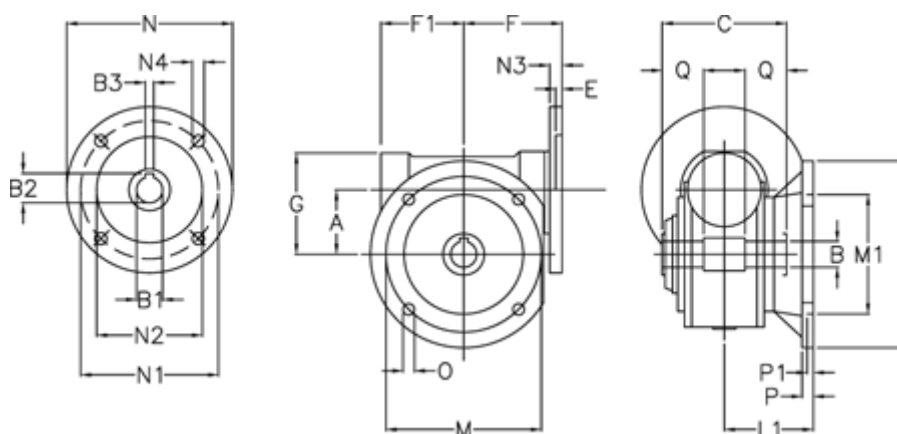

A = 150	F1 = 179	N2 = 230
B = 50 H7	G = 218	N3 = 16
B1 E7 = 38	L = 350	N4 = 13
B2 = 41.3	L1 = 145.5	O = 18
B3 H9 = 10	M = 290	P = 22
C = 175	M1 = 200	P1 = 13
E = 2	N = 300	Q = 55
F = 190	N1 = 265	